

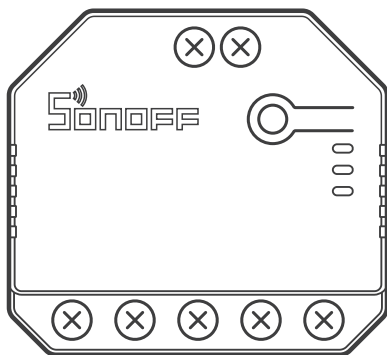

DUALR3 & Lite

User manual V1.3



2-Gang Wi-Fi Smart Switch

产品介绍

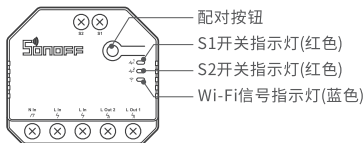

⚠ 设备重量<1Kg, 建议安装高度<2米。

产品特点

本设备为一款双通道的智能开关, 用您的智能手机在任何地方打开或关闭家里的设备, 设置定时开/关、分享给您的家人一起控制等等。



远程控制



智能定时/延时



分享功能



智能场景



同步状态



电量统计
(DUALR3)



过载保护
(DUALR3)



点动模式



上电状态设置



局域网功能

使用说明

1. 断电

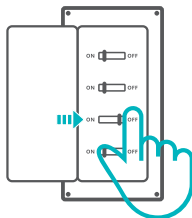

⚠ 设备安装、故障维修请由专业资质电工操作。切勿在设备通电时进行接线操作, 以免发生触电危险!

2. 接线

⚠ 请勿直接从火线处拉线到S1/S2外置的开关，必须从设备引出。

电机模式：

① 单键瞬时开关：

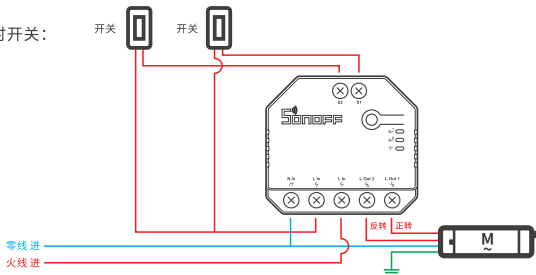

① S1/S2任意接一路开关即可实现正常开关控制使用，接两路可实现双控。

② 双键瞬时开关、三键翘板开关：

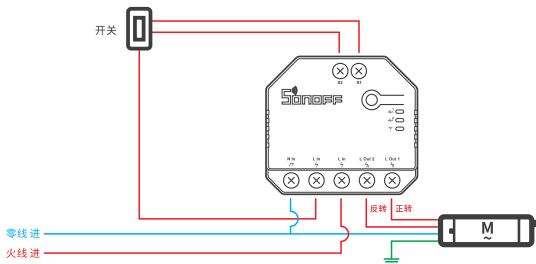

灯具接线示意：

① 脉冲触发模式下接回弹开关、边缘触发模式下接翘板开关实现两路控制：

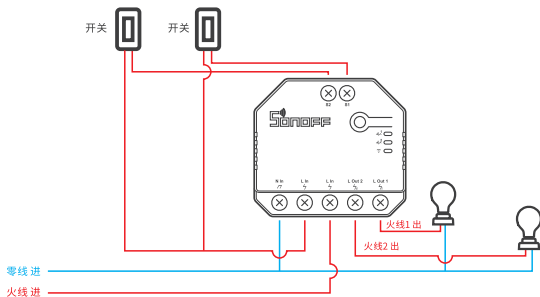

② 边缘触发模式下接单刀双掷开关实现两路双控：

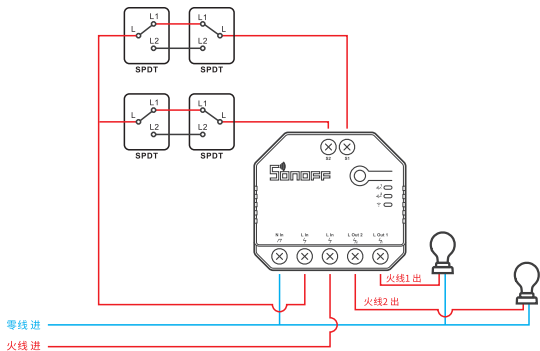

③ 跟随模式下接干接点输出信号传感器：

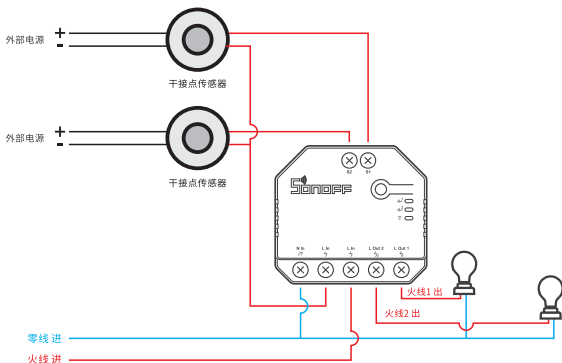

⚠ 确保线路接入无误。

⚠ S1/S2不接机械开关,不影响设备正常使用。

⚠ S1/S2外接机械开关使用时,需通过“易微联”APP选择工作模式方可使用。

⚠ 为确保电气安装的安全,必须在DUALR3,DUALR3 Lite 前面安装符合国家安全标准额定电流为15A的微型断路器(MCB)或漏电保护断路器(RCBO)。

3. 下载“易微联”APP

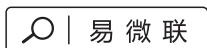

Android™ & iOS

4. 上电

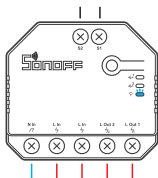

通电后, 设备首次使用, 默认进入蓝牙配网模式。Wi-Fi指示灯呈“两短一长闪烁”。

⚠ 3分钟内没有进行配网, 设备将退出蓝牙配网模式。如需再次进入, 长按配对按钮5秒直到Wi-Fi指示灯呈两短一长闪烁即可。

5. 添加设备

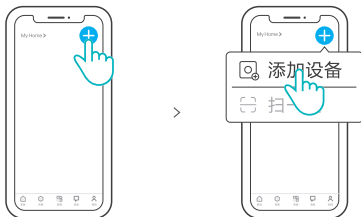

点击“+”，选择“添加设备”，再根据 App 提示进行操作。

⚠ 添加设备时必须打开手机蓝牙。

兼容模式配网

如使用蓝牙配网失败, 请使用“兼容模式”进行配对。

长按配对按钮5秒直到Wi-Fi指示灯呈“两短一长闪烁”状态, 松开。再次长按配对按钮5秒直到Wi-Fi指示灯呈“快闪”状态, 此时设备进入兼容配网模式。

Android设备:

在app界面, 点击“+”选择“添加设备”, 再选择“兼容模式”。

先把移动设备连接上Wi-Fi账号为: ITEAD-*****, 密码为: 12345678, 然后回到“易微联”app, 点击“下一步”, 等待配对完成。

iOS设备:

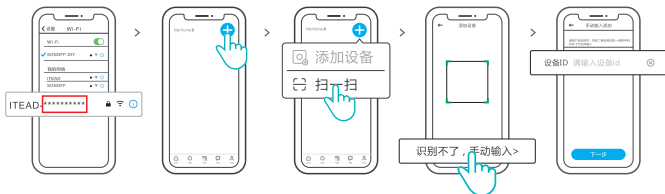

- ① 设备在兼容配网模式下, 在手机Wi-Fi列表找到账号为:ITEAD-*****, 请记录好 Wi-Fi 账号后10位的设备ID。
- ② 回到“易微联”app, 点击“+”, 选择“扫码添加”, 再点击屏幕下方“手动输入” 最后输入记录好的设备ID号, 点击下一步等待添加完成。

将设备安装在暗盒中

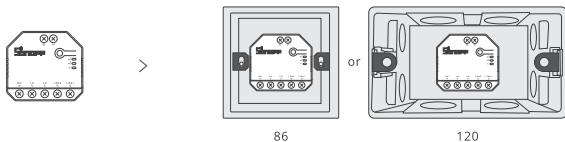

产品参数

型号	DUALR3, DUALR3 Lite
输入	100-240V~, 50/60Hz μ
阻性负载	2400W@240V~ 10A/通道, 3600W@240V~ 15A 总负载
电机负载	10-240W/1A
Wi-Fi	IEEE 802.11 b/g/n 2.4GHz
支持平台	Android & iOS
通道数量	双通道
工作温度	-10°C~40°C
外壳材料	PC V0
产品规格	54x49x24mm

Wi-Fi信号指示灯状态说明

指示灯状态	状态描述
两短一长闪烁	蓝牙配网模式
常亮	设备已连接
快闪	兼容配网模式
快闪一下	找不到路由
快闪二下	连接上路由, 但没连上服务器
快闪三下	升级中

工作模式

配对成功后, 请根据当前连接设备, 选择对应的工作模式(开关模式、电机模式或电表模式)。

开关模式:

独立控制两路输出负载。

电机模式:

适合接窗帘、卷帘电机等四线管状电机。

电表模式 (DUALR3):

继电器保持常开, 只有电量统计功能, 不能控制设备的开关。

更换设备网络

设备更换新的网络环境使用时, 需长按设备配对按钮5秒直到Wi-Fi指示灯呈两短一长闪烁, 松开, 此时设备进入蓝牙配网模式, 即可再次添加。

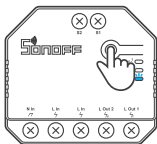

恢复出厂设置

在eWeLink app端“删除设备”，设备即恢复出厂设置。

常见问题

Wi-Fi设备与易微联APP配对失败

1. 确保设备进入配对模式。
三分钟内设备没有配对成功，则自动退出配对模式。
2. 请开启定位模式以及允许获取定位权限
配网前，请先开启手机的定位服务并允许获取定位权限，位置信息权限用于获取Wi-Fi列表信息。如果“禁用”手机定位服务，设备将无法添加。
3. 确保Wi-Fi运行在2.4GHz频段。
4. 确保正确输入Wi-Fi网络名称和密码，且没有包含特殊字符。
密码错误是常见的配对失败原因。
5. 配对时为了确保良好的信号传输，请将设备靠近路由器。
6. 请尝试在兼容模式下进行配对。

Wi-Fi设备“离线”问题

请根据Wi-Fi LED指示灯状态检查以下问题：

LED灯每2秒闪烁一次，路由器连接失败。

1. 输入不正确的Wi-Fi网络名称和密码。
2. 确保你的Wi-Fi网络名称和密码没有包含特殊字符。例如，我们的系统无法识别希伯来语和阿拉伯语字符，导致Wi-Fi连接失败；
3. 路由器承载力较低。
4. Wi-Fi信号太弱。路由器和设备间隔太远，或者路由器与设备之前有障碍物导致信号无法传输。
5. 确保设备的MAC地址在MAC管理的白名单中。

LED指示灯连续闪烁两次，服务器连接失败

1. 确保网络连接正常。你可以通过手机或者电脑连接网络。如果连接失败，请检查网络。
2. 路由器承载力较低。连接到路由器的设备超过最大值。请查看你的路由器可以连接的最大设备数量。如果超过最大值，请删除个别设备或者更换一个承载力较高的路由器再次连接。
3. 请联系你的网络服务供应商以确认服务器地址没有被屏蔽：
cn-disp.coolkit.cc (中国大陆)
as-disp.coolkit.cc (除中国外亚洲地区)
eu-disp.coolkit.cc (欧洲)
us-disp.coolkit.cc (美国)

如果以上方法均无法解决此问题，请在易微联APP上通过“帮助&反馈”提交你的问题。

产品中有害物质的名称及含量

部件名称	有害物质					
	铅 (Pb)	汞 (Hg)	镉 (Cd)	六价铬 (Cr(VI))	多溴联苯 (PBB)	多溴二苯醚 (PBDE)
塑料件	o	o	o	o	o	o
电子元器件	x	o	o	o	o	o
包装盒	o	o	o	o	o	o
PCB板	o	o	o	o	o	o
五金件	o	o	o	o	o	o

本表格依据SJ/T 11364 的规定编制：

- o：表示该有害物质在该部件所有均质材料中的含量均在GB/T 26572规定的限量要求以下；
x：表示该有害物质至少在该部件的某一均质材料中的含量超出GB/T 26572规定的限量要求。

执行标准：GB/T 16915.2

Product Introduction

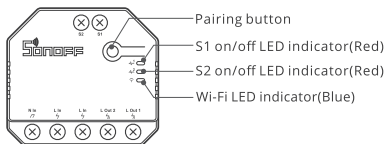

ⓘ The device weight is less than 1 kg. The installation height of less than 2 m is recommended.

Features

This device is a 2-gang Wi-Fi smart switch that allows you to remotely turn on/off the device, schedule it on/off or share it with your family to control together.



Remote Control



Single/Countdown
Timing



Share Control



Smart Scene



Sync Status



Power Monitoring
(DUALR3)



Over-load
Protection
(DUALR3)



Inching Mode



Power-on State



LAN Control

Operating Instruction

1. Power off

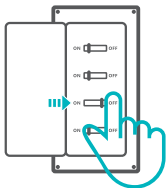

⚠ To avoid electric shocks, please consult the dealer or a qualified professional for help when installing and repairing! Do not wire when power is on.

2. Wiring instruction

⚠ Do not pull the wire directly from the live wire to the S1/S2 external switch! Must from device.

Motor mode:

① Momentary switch:

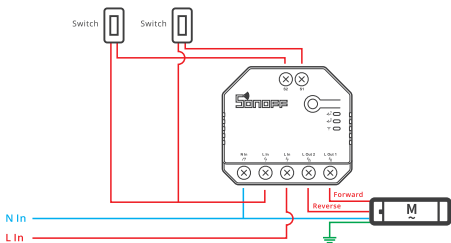

⚠ Connect to S1 or S2 for smart control of connected devices; connect to S1 and S2 for two-way smart control.

② Dual relay momentary switch/3-gang rocker switch:

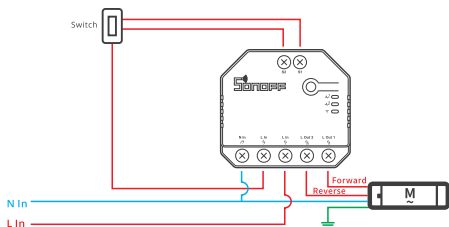

Light fixture wiring instruction:

- ① To enable dual relay control, S1 and S2 are required to connect the push button switch in the pulse mode or the rocker light switch in the edge mode:

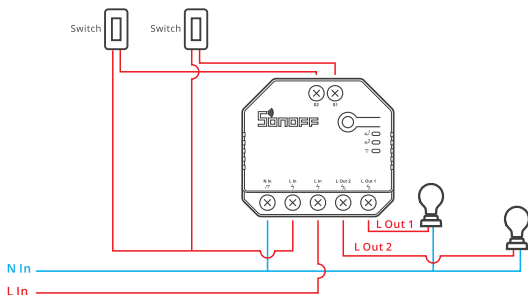

- ② Connect SPDT switches in the edge mode to reach double two-way control:

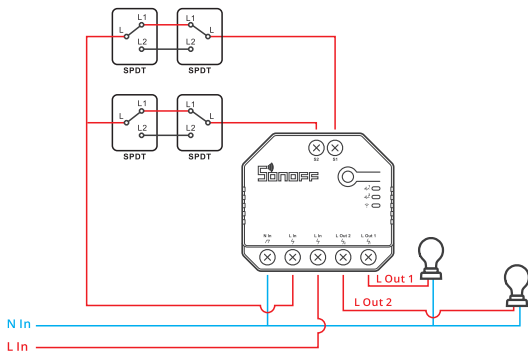

③ Connect dry contact sensors in the following mode:

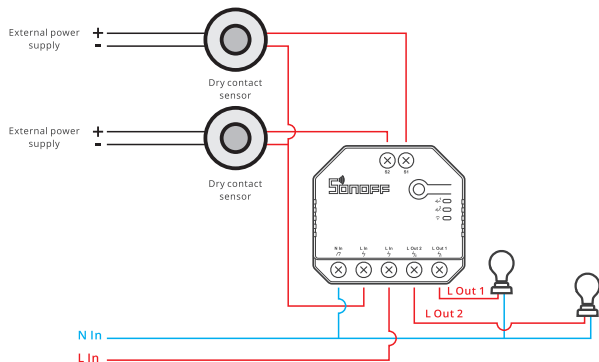

- ⚠ Make sure the neutral wire and live wire connection is correct.
- ⚠ The device still works normally if no a physical light switch is connected to S1/S2.
- ⚠ If S1/S2 is connected to a physical light switch, the corresponding working mode is required in eWeLink APP to select for normal use.
- ⚠ To ensure the safety of your electrical installation, it's essential either a Miniature Circuit Breaker (MCB) or a Residual Current operated Circuit-breaker with Integral Overcurrent protection(RCBO) with an electrical rating of 15A has been installed before the DUALR3,DUALR3 Lite .

3. Download the eWeLink App



4. Power on

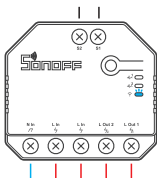

After powering on, the device will enter the bluetooth pairing mode during the first use. The Wi-Fi LED indicator changes in a cycle of two short and one long flash and release.

⚠ The device will exit the bluetooth pairing mode if not paired within 3mins. If you want to enter this mode, please long press the manual button for about 5s until the Wi-Fi LED indicator changes in a cycle of two short and one long flash and release.

5. Add the device

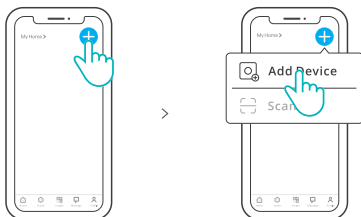

Tap "+" and select "Add Device", then operate following the prompt on the App.

⚠ It's required to turn on the Bluetooth on your Phone when adding a device.

Compatible Pairing Mode

If you fail to enter Bluetooth Pairing Mode, please try "Compatible Mode" to pair.

Long press Pairing button for 5s until the Wi-Fi LED indicator changes in a cycle of two short flashes and one long flash and release. Long press Pairing button for 5s again until the Wi-Fi LED indicator flashes quickly. Then, the device enters Compatible Pairing Mode.

For Android system:

Tap "+" and select "Add Device" then select "Compatible Mode" on APP.

Select Wi-Fi SSID with ITEAD-***** and enter the password 12345678, and then go back to eWeLink APP and tap "Next". Be patient until pairing completes.

For iOS system:

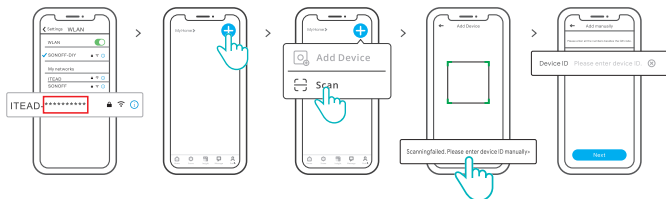

- ① When the device is in the compatible mode, please record the device ID ITEAD-*****, which can be found in the Wi-Fi list of the mobile phone.
- ② Enter Wi-Fi password, tap "Next" and then "Connect". Select Wi-Fi SSID with ITEAD-***** and enter the password 12345678, and then go back to eWeLink app and tap "Next". Be patient until pairing completes.

Install the device in the mounting box

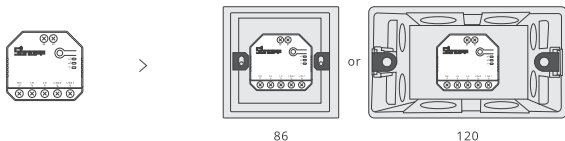

Specifications

Model	DUALR3, DUALR3 Lite
Rating	100-240V~, 50/60Hz μ
Resistive Load	2400W@240V~ 10A/Gang, 3600W@240V~ 15A Total
Motor Load	10-240W/1A
Wi-Fi	IEEE 802.11 b/g/n 2.4GHz
Frequency range	2400-2483.5Mhz
Version Information	Hardware Versions: V1.0 Software Versions: V1.0
Maximum RF output power	Wi-Fi:19dBm(e.i.r.p) BLE:4dBm(e.i.r.p)
Operating systems	Android & iOS
Number of gangs	2-Gang
Working temperature	-10°C~40°C
Material	PC V0
Dimension	54x49x24mm
Disconnection Type	Type 1B
Pollution degree	2
Rated impulse voltage	2500V

Wi-Fi LED indicator status instruction

LED indicator status	Status instruction
Flashes (one long and two short)	Bluetooth Pairing Mode
Keeps on	Device is connected successfully
Flashes quickly	Compatible Pairing Mode
Flashes quickly once	Unable to discover the router
Flashes quickly twice	Connect to the router but fail to connect to server
Flashes quickly three times	Upgrading

Working Mode

After pairing, select the corresponding mode from switch, motor and meter modes according to the connected device.

Switch Mode:

Control two output loads independently.

Motor Mode:

Suitable for four-wire tubular motors such as curtain and roller blind motor.

Meter Mode (DUALR3) :

The relay keeps on, and can not be turned off. Focusing on power metering.

Switch Network

If you need to change the network, long press the pairing button for 5s until the Wi-Fi LED indicator changes in a cycle of two short and one long flash and release, then the device enters Bluetooth pairing mode and you can pair again.

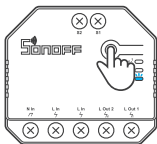

Factory Reset

Deleting the device on the eWeLink app indicates you restore it to factory setting.

Common Problems

Fail to pair Wi-Fi devices with eWeLink APP

1. Make sure the device is in pairing mode.
The device will automatically exit the pairing mode if not paired within 3mins.
2. Please turn on the location service on your mobile phone and give the permission.
Before choosing the Wi-Fi network, the location service should be turned on and the permission is given. Location information permission is used to obtain Wi-Fi list information. If you tap "Disable", the device will not be added.
3. Make sure your Wi-Fi network runs on the 2.4GHz band.
4. Make sure you entered a correct Wi-Fi SSID and password, no special characters contained. A wrong password is a very common reason for pairing failure.
5. You may get the device close to the router for a good signal transmission while pairing.
6. Please try to pair the device in the compatible mode.

Wi-Fi devices "Offline" issues

Please check the following issues by the Wi-Fi LED indicator status:

The LED indicator blinks once every 2s means you fail to connect to the router.

1. Maybe you entered a wrong Wi-Fi SSID and password.
2. Make sure your Wi-Fi SSID and password don't contain special characters, for example, the Hebrew, Arabic characters. Our system can't recognize these characters so that fail to connect to the Wi-Fi.
3. Maybe your router has a lower carrying capacity.
4. Maybe the Wi-Fi signal strength is weak. Your router is too far away from your device, or there may be some obstacles between the router and the device so that the signal transmission is blocked.
5. Be sure that the MAC of the device is not on the blacklist of your MAC management.

The LED indicator flashes twice on repeated means you fail to connect to the server.

1. Make sure the Internet connection is normal. You can use your phone or PC to connect to the Internet, and if you fail to access, please check the availability of the Internet connection.
2. Maybe your router has a low carrying capacity. The number of devices connected to the router exceeds its maximum value. Please check the maximum number of devices that your router can carry. If the number of connected devices exceeds the maximum value, please delete some devices or change a larger router and try again.
3. Please contact your ISP and confirm our server address is not shielded:
cn-disp.coolkit.cc (China Mainland)
as-disp.coolkit.cc (in Asia except China)
eu-disp.coolkit.cc (in EU)
us-disp.coolkit.cc (in US)

If none of the above methods solved this problem, please submit your issue via help & feedback on the eWeLink App.

FCC compliance statement

1.This device complies with part 15 of the FCC Rules. Operation is subject to the following two conditions:

- (1) This device may not cause harmful interference, and
- (2) This device must accept any interference received, includinginterference that may cause undesired operation.

2.Changes or modifications not expressly approved by the party responsible for compliance could void the user's authority to operate the equipment.

Note: This equipment has been tested and found to comply with the limits for a Class B digital device, pursuant to part 15 of the FCC Rules. These limits are designed to provide reasonable protection against harmful interference in a residential installation. This equipment generates, uses and can radiate radio frequency energy and, if not installed and used in accordance with the instructions, may cause harmful interference to radio communications. However, there is no guarantee that interference will not occur in a particular installation. If this equipment does cause harmful interference to radio or television reception, which can be determined by turning the equipment off and on, the user is encouraged to try to correct the interference by one or more of the following measures:

- Reorient or relocate the receiving antenna.
- Increase the separation between the equipment and receiver.
- Connect the equipment into an outlet on a circuit different from that to which the receiver is connected.
- Consult the dealer or an experienced radio/TV technician for help.

FCC Radiation Exposure statement:

This equipment complies with FCC radiation exposure limits set forth for an uncontrolled environment.

This equipment should be installed and operated with minimum distance of 20 cm between the radiator and your body.

This transmitter must not be co-located or operating in conjunction with any other antenna or transmitter.

Scatola	Manuale
PAP 21	PAP 22
Carta	Carta
RACCOLTA	
Verifica le disposizioni del tuo Comune. Separa le componenti e conferiscile in modo corretto.	

ISED Notice

This device contains licence-exempt transmitter(s)/receiver(s) that comply with Innovation, Science and Economic Development Canada's licence-exempt RSS(s). Operation is subject to the following two conditions:

(1) This device may not cause interference.

(2) This device must accept any interference, including interference that may cause undesired operation of the device.

This Class B digital apparatus complies with Canadian ICES-003(B).

This device complies with RSS-247 of Industry Canada.

Operation is subject to the condition that this device does not cause harmful interference.

L'émetteur/récepteur exempt de licence contenu dans le présent appareil est conforme aux CNR d'Innovation, Sciences et Développement économique Canada applicables aux appareils radio exempts de licence. L'exploitation est autorisée aux deux conditions suivantes :

(1) L'appareil ne doit pas produire de brouillage;

(2) L'appareil doit accepter tout brouillage radioélectrique subi, même si le brouillage est susceptible d'en compromettre le fonctionnement.

Cet appareil numérique de la Classe B conforme à la norme NMB-003(B) du Canada.

Cet appareil est conforme à la norme RSS - 247 d'Industrie

Canada. Le fonctionnement est soumis à la condition que cet appareil ne provoque pas d'interférences nuisibles.

ISED Radiation Exposure Statement

This equipment complies with ISED radiation exposure limits set forth for an uncontrolled environment. This equipment should be installed and operated with minimum distance of 20 cm between the radiator and your body.

This transmitter must not be co-located or operating in conjunction with any other antenna or transmitter.

Cet équipement est conforme aux limites d'exposition aux rayonnements de la ISED établies pour un environnement non contrôlé.

Cet équipement doit être installé et fonctionner à au moins 20cm de distance d'un radiateur ou de votre corps.

Cet émetteur ne doit pas être co-localisé ou fonctionner en conjonction avec une autre antenne ou un autre émetteur.

Important Safety Instructions

1. CAUTION : Risk of electric shock, This product is not a toy and not intended for use by children. For adult use only.
2. The maximum ambient temperature during use of the appliance must not exceed 40°C.
3. The appliance is suitable for moderate climates only.
4. The ventilation must not be impaired by covering the appliance with items such as newspapers, table cloths, curtains, etc.
5. Naked flame sources, such as candles, must not be placed on the appliance.

SAR Warning

Under normal use of condition, this equipment should be kept a separation distance of at least 20 cm between the antenna and the body of the user.

Dans des conditions normales d'utilisation, cet équipement doit être maintenu à une distance d'au moins 20 cm entre l'antenne et le corps de l'utilisateur.

WEEE Disposal and Recycling Information



All products bearing this symbol are waste electrical and electronic equipment (WEEE as in directive 2012/19/EU) which should not be mixed with unsorted household waste. Instead, you should protect human health and the environment by handing over your waste equipment to a designated collection point for the recycling of waste electrical and electronic equipment, appointed by the government or local authorities. Correct disposal and recycling will help prevent potential negative consequences to the environment and human health. Please contact the installer or local authorities for more information about the location as well as terms and conditions of such collection points.

For CE Frequency

EU Operating Frequency Range

Wi-Fi: 802.11 b/g/n20: 2412–2472 MHz, 802.11 n40: 2422-2462 MHz
BLE: 2402–2480 MHz

EU Output Power

Wi-Fi 2.4G ≤ 20 dBm
BLE ≤ 13 dBm

EU Declaration of Conformity

Hereby, Shenzhen Sonoff Technologies Co., Ltd. declares that the radio equipment type DUALR3, DUALR3 Lite is in compliance with Directive 2014/53/EU. The full text of the EU declaration of conformity is available at the following internet address: <https://sonoff.tech/compliance/>



Shenzhen Sonoff Technologies Co., Ltd.

1001, BLDG8, Lianhua Industrial Park, shenzhen, GD, China

ZIP code: 518000

Website: sonoff.tech

Service email: support@itead.cc

MADE IN CHINA

