

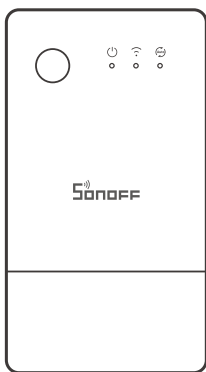

TH Origin/Elite

User manual V1.4



TH Origin

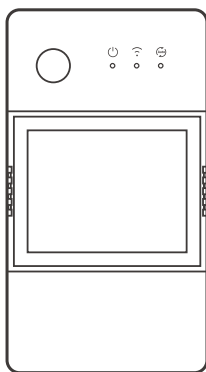

TH Elite

Smart Temperature and Humidity Monitoring Switch

产品介绍

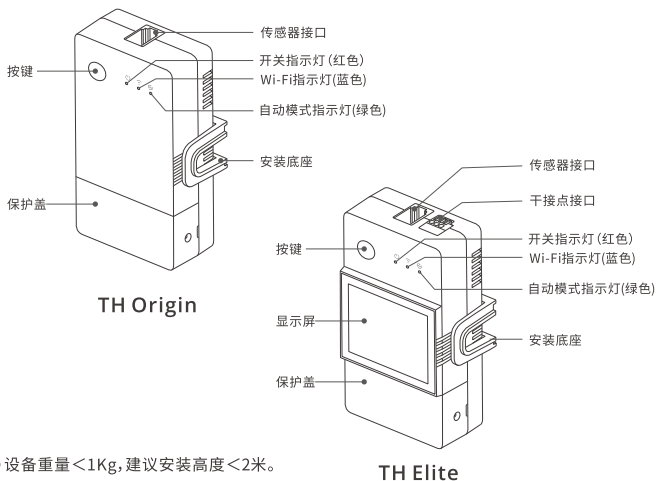

按键功能

| 动作 | 结果 |
|------|-----------|
| 单击 | 设备开/关 |
| 双击 | 自动模式开启/关闭 |
| 长按5秒 | 进入配网模式 |

信号指示灯状态说明

| 指示灯状态 | 状态说明 |
|----------|------------------|
| 蓝灯两短一长闪烁 | 配网模式 |
| 蓝灯常亮 | 设备在线 |
| 蓝灯快闪一下 | 未连接路由 |
| 蓝灯快闪二下 | 已连接上路由器, 但未连接到云端 |
| 蓝灯快闪三下 | 固件升级中 |
| 绿灯常亮 | 自动模式开启 |

功能特点

TH Origin/Elite是一款带温湿度检测的智能开关改装件，需连接配套的温湿度传感器一起使用。



温度和湿度监测



温度和湿度历史数据



自动模式



分享控制



点动模式



语音控制



智能定时/延时



局域网功能



干接点
(TH Elite)



屏幕显示
(TH Elite)

设备安装

1. 断电

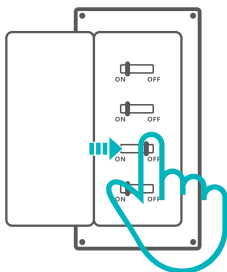

警告

设备安装、故障维修请由专业资质电工操作。切勿在设备通电时进行接线操作或触碰到接线端子，以免发生触电危险！

2. 接线

2-1 取下保护盖

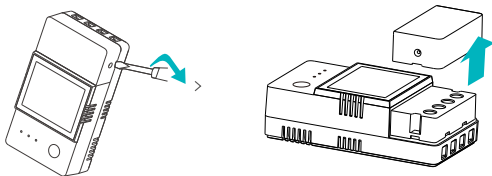

2-2

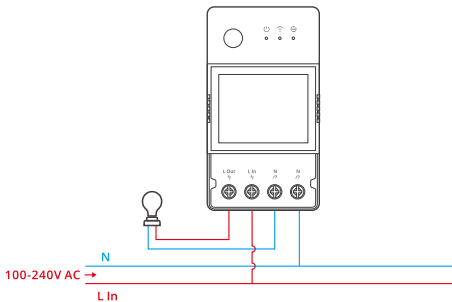

2-3 干接点接线方法

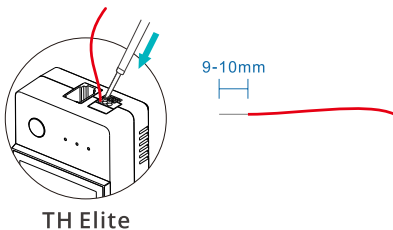

按下接线孔对应上方的白色按钮同时将线材插入，松开按钮即可。

⚠ 干接点接线线材单根线径范围 $0.13-0.5\text{mm}^2$ ，剥线长度：9-10mm。

⚠ 确保线路接入无误。

2-4 35mm 导轨安装

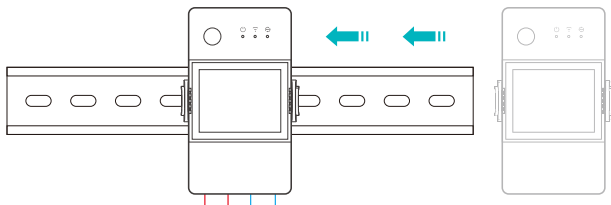

先把导轨固定在设备需要安装的位置,再把设备底座卡扣对准导轨侧边滑动即可。

2-5 插入传感器

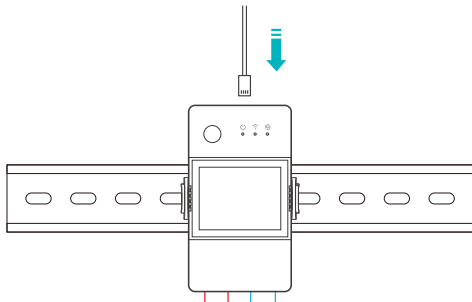

兼容的SONOFF传感器:WTS01, MS01, THS01, AM2301, Si7021。

兼容的传感器延长线:RL560。

⚠ 部分老版本传感器需与附赠的转接头一起使用。

设备配对

1. 下载“易微联”App



2. 上电

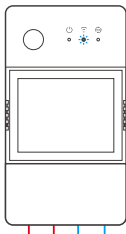

通电后，设备首次使用，默认进入配网模式。Wi-Fi指示灯呈“两短一长闪烁”。

⚠ 3分钟内没有进行配网，设备将退出蓝牙配网模式。如需再次进入，长按设备按键5秒直到Wi-Fi指示灯呈两短一长闪烁即可。



3. 添加设备

方法1: 蓝牙配网

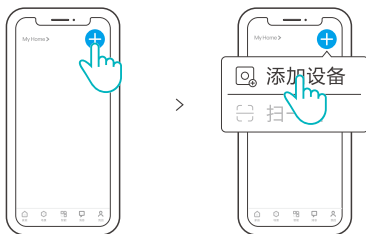

点击“+”，选择“添加设备”，再根据 App 提示进行操作。

方法2: 扫码添加



在配网模式下, 选择“扫一扫”, 扫描设备背面的二维码进行配对。

Alexa 语音控制教程

1. 下载 Alexa App 并登录账号。



2. 在 Alexa App 中添加 Echo 音箱

3. 账号关联 (从 eWeLink App 中关联 Alexa 账号)

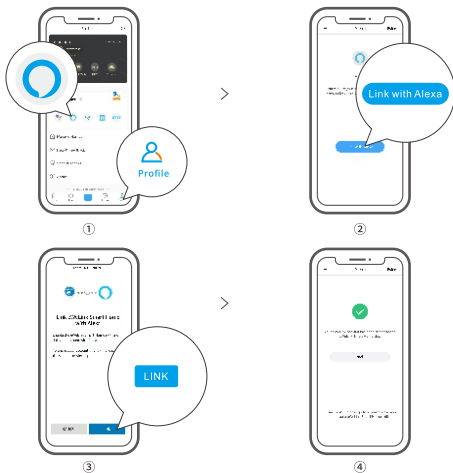

4. 关联完成后, 再根据 Alexa App 提示完成发现设备。

ⓘ Google Assistant、小度、天猫精灵、小爱同学的语音控制绑定方式类似, 具体请参考App上的说明。

产品参数

| | |
|---------|------------------------------------------------------------------------------------------------------------------------|
| 产品型号 | THR316, THR320, THR316D, THR320D |
| 输入 | THR316, THR316D: 100-240V ~ 50/60Hz 16A Max THR320, THR320D: 100-240V ~ 50/60Hz 20A Max |
| 输出 | THR316, THR316D: 100-240V ~ 50/60Hz 16A Max THR320, THR320D: 100-240V ~ 50/60Hz 20A Max |
| 干接点输出 | 5-30V, 1A Max |
| Wi-Fi | IEEE 802.11 b/g/n 2.4GHz |
| 屏幕显示大小 | THR316D, THR320D: 43x33mm |
| App支持系统 | Android & iOS |
| 工作温度 | -10°C~40°C |
| 工作湿度 | 5%-95%RH,无冷凝 |
| 外壳材料 | PC V0 |
| 产品规格 | THR316, THR320: 98x54x27.5mm THR316D, THR320D: 98x54x31mm |
| 接线线径范围 | THR316, THR316D: 1.0mm ² to 4.0mm ² THR320, THR320D: 1.5mm ² to 6.0mm ² |

局域网控制

手机与设备连接同一个WiFi, 不通过云平台, 直接对设备进行控制的通讯方式。

- ⓘ 无外网连接时, 不支持新增定时、延时、循环定时、操作通知、操作记录、固件升级、智能场景、分享设备、删除设备。

控制模式

手动模式: 随时通过 App、设备按键等方式控制设备开关

自动模式: 通过设定的温度或湿度阈值自动地控制设备开关

- ⓘ 自动模式设置:

设置温室/湿度阈值及生效时间段, 最多可设置8个不同时间段的自动控制程序。

自动模式开启/关闭

双击设备上按键或在App中启用/关闭

- ⓘ 手动控制与自动控制模式同时存在, 没有优先级。自动模式下能手动控制开关, 一段时间后, 自动模式检测到温湿度变化, 会恢复执行。

恢复出厂设置

在 eWeLink App 端“删除设备”，设备即恢复出厂设置。

常见问题

Wi-Fi设备与 eWeLink APP 配对失败。

1. 确保设备处于配对模式。三分钟内没进行配网，设备将自动退出配对模式。
2. 请开启定位服务并允许定位权限。在选择 Wi-Fi 网络之前，请开启定位服务并允许定位权限。位置信息权限用于获取 Wi-Fi 列表信息。如果单击禁用，您将无法添加设备。
3. 确保您的 Wi-Fi 网络为 2.4GHz 频段。
4. 确保您输入了正确的 Wi-Fi SSID 和密码，没有包含特殊字符。密码错误是配对失败的一个非常常见的原因。
5. 配对时设备应靠近路由器，以保证良好的传输信号条件。

Wi-Fi 设备“离线”问题，请通过 Wi-Fi LED 指示灯状态检查以下问题：

LED 指示灯每 2 秒闪烁一次，表示您无法连接到路由器。

1. 可能您输入了错误的 Wi-Fi SSID 和密码。
2. 确保您的 Wi-Fi SSID 和密码不包含特殊字符，例如希伯来语、阿拉伯语字符，我们的系统无法识别这些字符，因此无法连接到 Wi-Fi。
3. 可能你的路由器承载能力较低。
4. 可能是 Wi-Fi 强度较弱。您的路由器距离您的设备太远，或者路由器和设备之间可能存在阻碍信号传输的障碍物。

LED 指示灯重复闪烁两次表示您无法连接到服务器。

1. 确保互联网连接正常。您可以使用您的手机或PC连接互联网，如果无法访问，请检查互联网连接的可用性。
 2. 可能你的路由器承载能力低。连接到路由器的设备数量超过其最大值。请确认您的路由器可以携带的最大设备数量。如果超过，请删除一些设备或换个更大的路由器再试。
- 如果以上方法均无法解决此问题，请通过 eWeLink APP 上的帮助&反馈提交您的请求。

本产品的无线电发射设备型号核准代码印于产品机身
 执行标准:GB 14536.1

产品中有害物质的名称及含量

| 部件名称 | 有害物质 | | | | | |
|-------|-----------|-----------|-----------|-----------------|---------------|-----------------|
| | 铅 (Pb) | 汞 (Hg) | 镉 (Cd) | 六价铬 (Cr{VI}) | 多溴联苯 (PBB) | 多溴二苯醚 (PBDE) |
| 塑料件 | o | o | o | o | o | o |
| 电子元器件 | x | o | o | o | o | o |
| 包装盒 | o | o | o | o | o | o |
| PCB板 | o | o | o | o | o | o |
| 五金件 | o | o | o | o | o | o |

本表格依据SJ/T 11364 的规定编制:

o: 表示该有害物质在该部件所有均质材料中的含量均在GB/T 26572规定的限量要求以下;
 x: 表示该有害物质至少在该部件的某一均质材料中的含量超出GB/T 26572规定的限量要求。



为确保电气安装的安全,必须在开关前面安装符合国家安全标准额定电流为16A(THR316, THR316D), 20A(THR320,THR320D) 的微型断路器 (MCB) 或漏电断路器 (RCBO)。

Product Introduction

TH Origin

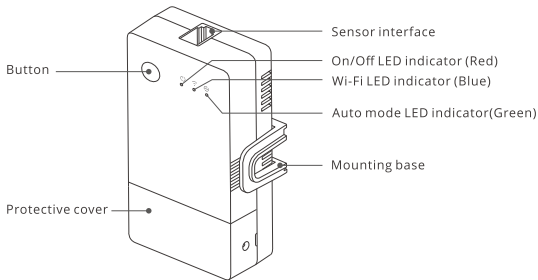

TH Elite

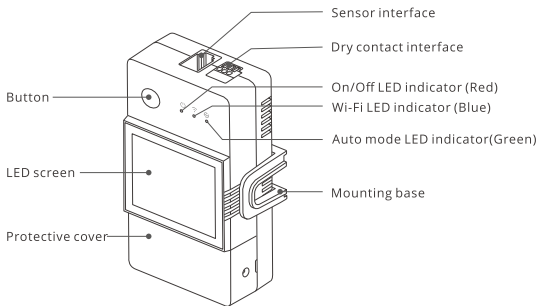

- ⚠ The device weight is less than 1kg.
The installation height of less than 2m is recommended.

Buttons instructions

| Actions | Results |
|-------------------|--------------------------|
| Single-click | Device on/off |
| Double-click | Auto-mode enable/disable |
| Long press for 5s | Enter the Pairing mode |

LED indicator status instruction

| LED indicator status | Status instruction |
|----------------------------------------------------|---------------------------------------------------|
| Blue LED indicator flashes(one long and two short) | Pairing mode |
| Blue LED indicator keeps on | Device is online |
| Blue LED indicator quick flashes once | Fail to connect to router |
| Blue LED indicator quick flashes twice | Connected to router but fail to connect to server |
| Blue LED indicator quick flashes three times | Firmware updating |
| Green LED indicator keeps on | Auto-mode is on |

Features

TH Origin/Elite is a DIY smart switch with temperature and humidity monitoring, and required to use with the temperature and humidity sensors correspondingly. Automatically control the channel switch by setting the temperature or humidity threshold on the App.



Sensing Control

Temp & Humi
History Data Graph

Automatic Mode



Share Control



Inching Mode



Voice Control



Timer Schedule



LAN Control

Wet & Dry Contact
(TH Elite)Screen Display
(TH Elite)

Device Installation

1. Power off

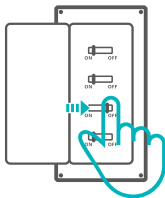

WARNING

Please install and maintain the device by a professional electrician. To avoid electric shock hazard, do not operate any connection or contact the terminal connector while the device is powered on!

2. Wiring instruction

2-1 Remove protective cover

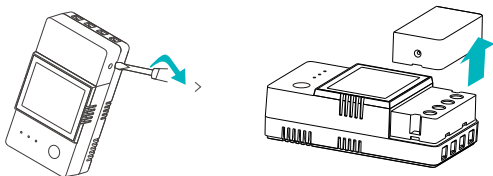

2-2

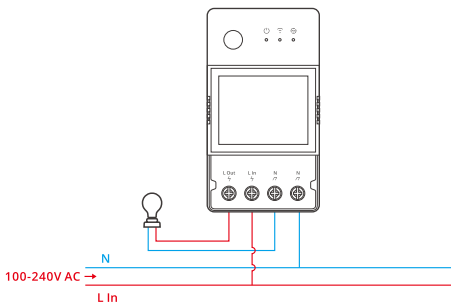

2-3 Wiring method of dry contact

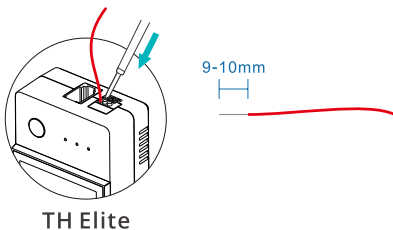

Press the white button on the top of the wire connecting hole to insert the wire corresponding, then release.

⚠ Dry contact wire conductor size: $0.13-0.5\text{mm}^2$, wire stripping length: 9-10mm.

⚠ Make sure all wires are connected correctly.

2-4 35mm rail installation

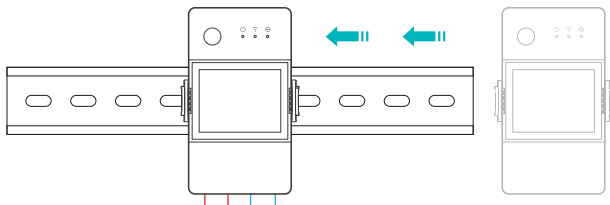

First fix the guide rail at the position where the equipment needs to be installed, and then slide the device base buckle against the side of the guide rail.

3. Insert the sensor

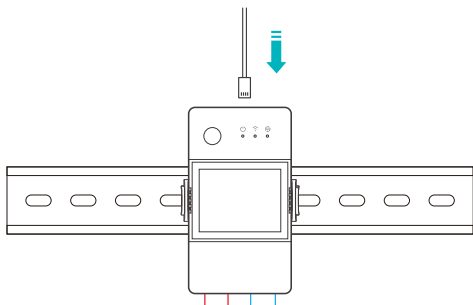

Compatible SONOFF sensors: WTS01, MS01, THS01, AM2301, Si7021.

Compatible sensor extension cables: RL560.

⚠ Some old version sensors need to be used with the accompanying adapter.

Device pairing

1. Download the eWeLink App

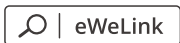

Android™ & iOS

2. Power on

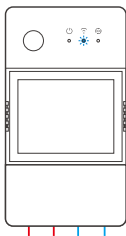

After powering on, the device will enter the Bluetooth Pairing Mode during the first use. The Wi-Fi LED indicator changes in a cycle of two short and one long flash and release.

- ⓘ The device will exit the Bluetooth Pairing Mode if not paired within 3mins. If you want to enter this mode, please long press button for about 5s until the Wi-Fi LED indicator changes in a cycle of two short and one long flash and release.



3. Add device

Method 1: Bluetooth Pairing

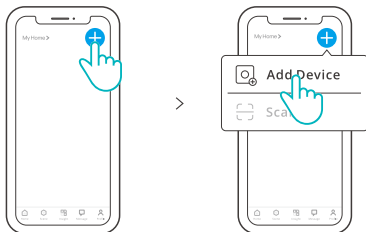

Tap “+” and select “Add device”, then operate following the prompt on the App.

Method 2: Scan QR code



In the Pairing mode, tap “Scan” to add the device by scanning the QR code on its back.

Alexa voice control instructions

1. Download the Amazon Alexa App and sign up an account.



Amazon Alexa

2. Add Amazon Echo Speaker on the Alexa App.

3. Account Linking (Link Alexa account on the eWeLink App)

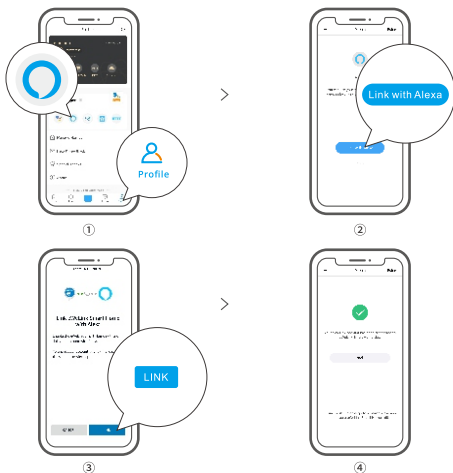

4. After linking the accounts, you can discover devices to connect on the Alexa App according to the prompt.

ⓘ Account linking method of Google Assistant, Xiaodu, Tmall Genie, Mate Xiaoai and etc is similar., the guides on the App shall prevail.

Specifications

| | |
|-----------------------------|------------------------------------------------------------------------------------------------------------------------|
| Model | THR316, THR320, THR316D, THR320D |
| Input | THR316, THR316D: 100-240V ~ 50/60Hz 16A Max THR320, THR320D: 100-240V ~ 50/60Hz 20A Max |
| Output | THR316, THR316D: 100-240V ~ 50/60Hz 16A Max THR320, THR320D: 100-240V ~ 50/60Hz 20A Max |
| Dry contact output | 5-30V, 1A Max |
| Wi-Fi | IEEE 802.11 b/g/n 2.4GHz |
| LED screen size | THR316D, THR320D: 43x33mm |
| App supported systems | Android & iOS |
| Operating temps | 10T40 (-10°C~40°C) |
| Working humidity | 5%-95% RH, non-condensing |
| Shell material | PC V0 |
| Dimension | THR316, THR320: 98x54x27.5mm THR316D, THR320D: 98x54x31mm |
| High voltage connector wire | THR316, THR316D: 1.0mm ² to 4.0mm ² THR320, THR320D: 1.5mm ² to 6.0mm ² |
| Rated impulse voltage | 2500V |
| Remark | External preliminary protection with Max. C 20 A circuit breaker in the supply line required under all circumstances. |

LAN control

A communication method to control the devices directly without going through the Cloud, which requires your smartphone and device connect to the same WIFI.

- ⚠ Operation notifications, operation records, firmware upgrades, smart scenes, devices sharing and devices delete are not supported when there is no external network connection.

Control modes

Manual mode: Turn on/off the device through the App and device itself whenever you want.

Auto mode: Turn on/off the device automatically through presetting the threshold of temperature and humidity.

- ⚠ **Auto mode setting:** Set the threshold of temperature & humidity and effective time period, you can set up 8 automatic control programs in different time periods

Auto mode enable/disable

Enable/disable the auto mode by double click the button on the device or enable/disable it on the App directly.

- ⓘ Manual control and Auto mode can work at the same time. In the auto mode, you can turn on/off the device manually. After a while, auto mode will resume execution if it detects changes in temperature and humidity.

Factory Reset

Deleting the device on the eWeLink app indicates you restore it to factory setting.

Common Problems

Fail to pair Wi-Fi devices to eWeLink APP

1. Make sure the device is in pairing mode. After three minutes of unsuccessful pairing, the device will automatically exit pairing mode.
2. Please turn on location services and allow location permission. Before choosing the Wi-Fi network, location services should be turned on and location permission should be allowed. Location information permission is used to obtain Wi-Fi list information. If you click Disable, you will not be able to add devices.
3. Make sure your Wi-Fi network runs on the 2.4GHz band.
4. Make sure you entered a correct Wi-Fi SSID and password, no special characters contained. Wrong password is a very common reason for pairing failure.
5. The device shall get close to the router for a good transmission signal condition while pairing.

Wi-Fi devices "Offline" issue, Please check the following problems by the Wi-Fi LED indicator status:

The LED indicator blinks once every 2s means you fail to connect to the router.

1. Maybe you entered the wrong Wi-Fi SSID and password.
2. Make sure that your Wi-Fi SSID and password don't contain special characters, for example, the Hebrew, Arabic characters, our system can't recognize these characters and then fail to connect to the Wi-Fi.
3. Maybe your router has a lower carrying capacity.
4. Maybe the Wi-Fi strength is weak. Your router is too far away from your device, or there may be some obstacle between the router and device which blocks the signal transmission.

The LED indicator flashes twice on repeated means you fail to connect to the server.

1. Make sure the Internet connection is working. You can use your phone or PC to connect to the Internet, and if it fails to access, please check the availability of the Internet connection.
2. Maybe your router has a low carrying capacity. The number of devices connected to the router exceeds its maximum value. Please confirm the maximum number of devices that your router can carry. If it exceeds, please delete some devices or get a larger router and try again.

If none of the above methods solved this problem, please submit your request via help&feedback on the eWeLink App.

FCC Warning

Changes or modifications not expressly approved by the party responsible for compliance could avoid the user's authority to operate the equipment.

This device complies with part 15 of the FCC Rules. Operation is subject to the following two conditions: (1) This device may not cause harmful interference, and (2) this device must accept any interference received, including interference that may cause undesired operation.

FCC Radiation Exposure Statement:

This equipment complies with FCC radiation exposure limits set forth for an uncontrolled environment. This equipment should be installed and operated with minimum distance 20cm between the radiator & your body. This transmitter must not be co-located or operating in conjunction with any other antenna or transmitter.

Note:

This equipment has been tested and found to comply with the limits for a Class B digital device, pursuant to part 15 of the FCC Rules. These limits are designed to provide reasonable protection against harmful interference in a residential installation. This equipment generates, uses and can radiate radio frequency energy and, if not installed and used in accordance with the instructions, may cause harmful interference to radio communications. However, there is no guarantee that interference will not occur in a particular installation. If this equipment does cause harmful interference to radio or television reception, which can be determined by turning the equipment off and on, the user is encouraged to try to correct the interference by one or more of the following measures:

- Reorient or relocate the receiving antenna.
- Increase the separation between the equipment and receiver.
- Connect the equipment into an outlet on a circuit different from that to which the receiver is connected.
- Consult the dealer or an experienced radio/TV technician for help.

ISED Notice

This device contains licence-exempt transmitter(s)/receiver(s) that comply with Innovation, Science and Economic Development Canada's licence-exempt RSS(s). Operation is subject to the following two conditions:

- (1) This device may not cause interference.
- (2) This device must accept any interference, including interference that may cause undesired operation of the device.

This Class B digital apparatus complies with Canadian ICES - 003(B).

This device complies with RSS - 247 of Industry Canada. Operation is subject to the condition that this device does not cause harmful interference.

L'émetteur/récepteur exempt de licence contenu dans le présent appareil est conforme aux CNR d'Innovation, Sciences et Développement économique Canada applicables aux appareils radio exempts de licence. L'exploitation est autorisée aux deux conditions suivantes :

- (1) L'appareil ne doit pas produire de brouillage;
- (2) L'appareil doit accepter tout brouillage radioélectrique subi, même si le brouillage est susceptible d'en compromettre le fonctionnement.

Cet appareil numérique de la Classe B conforme à la norme NMB - 003(B) du Canada.

Cet appareil est conforme à la norme RSS - 247 d'Industrie Canada. Le fonctionnement est soumis à la condition que cet appareil ne provoque pas d'interférences nuisibles.

ISED Radiation Exposure Statement

This equipment complies with ISED radiation exposure limits set forth for an uncontrolled environment.

This equipment should be installed and operated with minimum distance of 20 cm between the radiator and your body.

This transmitter must not be co-located or operating in conjunction with any other antenna or transmitter.

Cet équipement est conforme aux limites d'exposition aux rayonnements de la ISED établies pour un environnement non contrôlé.

Cet équipement doit être installé et fonctionner à au moins 20cm de distance d'un radiateur ou de votre corps.

Cet émetteur ne doit pas être co-localisé ou fonctionner en conjonction avec une autre antenne ou un autre émetteur.

EU Declaration of Conformity

Hereby, Shenzhen Sonoff Technologies Co., Ltd. declares that the radio equipment type THR316, THR316D, THR320, THR320D is in compliance with Directive 2014/53/EU. The full text of the EU declaration of conformity is available at the following internet address: <https://sonoff.tech/compliance/>

For CE Frequency

EU Operating Frequency Range

BLE: 2402–2480 MHz

Wi-Fi: 802.11 b/g/n20 2412–2472 MHz, 802.11 n40: 2422–2462 MHz

EU Output Power

BLE ≤ 10 dBm

Wi-Fi 2.4G ≤ 20 dBm

WEEE Disposal and Recycling Information



All products bearing this symbol are waste electrical and electronic equipment (WEEE as in directive 2012/19/EU) which should not be mixed with unsorted household waste. Instead, you should protect human health and the environment by handing over your waste equipment to a designated collection point for the recycling of waste electrical and electronic equipment, appointed by the government or local authorities. Correct disposal and recycling will help prevent potential negative consequences to the environment and human health. Please contact the installer or local authorities for more information about the location as well as terms and conditions of such collection points.

Warning

Under normal use of condition, this equipment should be kept a separation distance of at least 20 cm between the antenna and the body of the user.

Dans des conditions normales d'utilisation, cet équipement doit être maintenu à une distance d'au moins 20 cm entre l'antenne et le corps de l'utilisateur.

| | | | |
|---------------------------------------------------------------------------------------------------|---------|----------|----------|
| Scatola | Manuale | Borsa | Borsa |
| PAP 21 | PAP 22 | LDPE 4 | CPE 7 |
| Carta | Carta | Plastica | Plastica |
| RACCOLTA DIFFERENZIATA | | | |
| Verifica le disposizioni del tuo Comune. Separa le componenti e conferiscile in modo corretto. | | | |



To ensure the safety of your electrical installation, it's essential either a Miniature Circuit Breaker (MCB) or a Residual Current Operated Circuit Breaker (RCBO) with an electrical rating of 16A (THR316, THR316D), 20A (THR320, THR320D) has been installed before the switch.

SONOFF

Shenzhen Sonoff Technologies Co., Ltd.

3F & 6F, Bldg A, No. 663, Bulong Rd, Shenzhen, Guangdong, China

ZIP code: 518000 Website: sonoff.tech Service email: support@itead.cc

MADE IN CHINA

